



Mars II Convertible Redundancy On-Line UPS

The Mars II convertible series On-line double conversion UPS with full-time Digital Signal Processor control technology is the perfect solution for mission critical users who demand high reliability, availability and performance from a UPS. Input power factor correction, high efficiency and parallel redundant capability provide a superior level of power quality for sensitive electronic equipment and computer loads.

- Rack/Tower Convertible Design
- Simple Parallel Installation
- Full-time Digital Signal Processor Control
- Programmable Frequency Converter
- LCD/LED Mimic Panel
- Smart ECO Mode
- Simple and Easy to Use
- Power Range and Runtime Scalability
- Optional Galvanic Isolation Transformer
- Hot Swappable Battery



N+1 Parallel



Easy Communication



Hot Swappable



Power Share



Self-Diagnostics

Mars II Convertible Redundancy On-Line UPS

U Using our field proven Digital Signal Processor(DSP) with SMD techniques, the Mars II convertible series UPS achieves high reliability and greater immunity from utility power problems. The front display panel provides all major systems parameters and operational status of the UPS that include full diagnostics for simple, easy servicing. The Mars II convertible series UPS uses a patented inverter control technology that allows it to achieve N+1 scalable redundant power without the use of additional components. The Mars II convertible parallel configuration also eliminates any single point of failure.

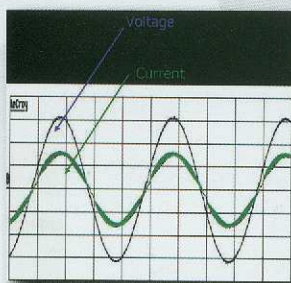
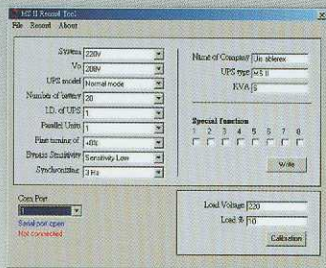
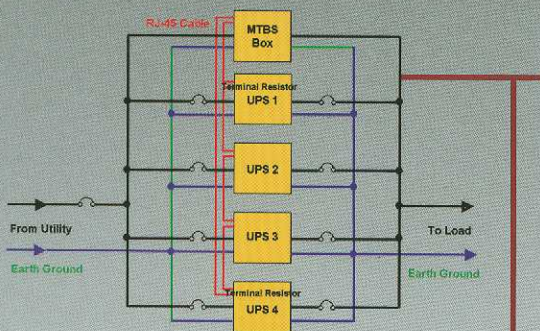

Simple Parallel Installation

To increase the power capacity or configuring a parallel redundant UPS system, up to 3 additional Mars II convertible series UPS are simply interconnected using the CAN-bus RJ45 cables on the rear of the Mars II convertible series UPS.

Programmable Frequency Converter

The Mars II convertible series UPS may be used as a frequency converter. Simple programming through the front LCD panel provides the convenience of 50 or 60Hz.

Intelligent Self-Diagnostics

The Mars II convertible series UPS with DSP Control, systematically checks each component and displays the result using on LCD display. This feature allows service technicians the ability to pinpoint and repair the UPS very quickly.

High Input Power Factor and Low Current THD

The Mars II convertible series UPS provides a 'clean' rectifier connection to utility source. It meets today's industry standard for energy saving with low reflected harmonic pollution to utility. The Mars II convertible series UPS achieves up to 0.99 Input Power Factor as well as <6% Input Current THD.

Cold Start Function

The Mars II convertible series UPS may be powered up without the presence of utility, providing AC power for immediate power requirements.

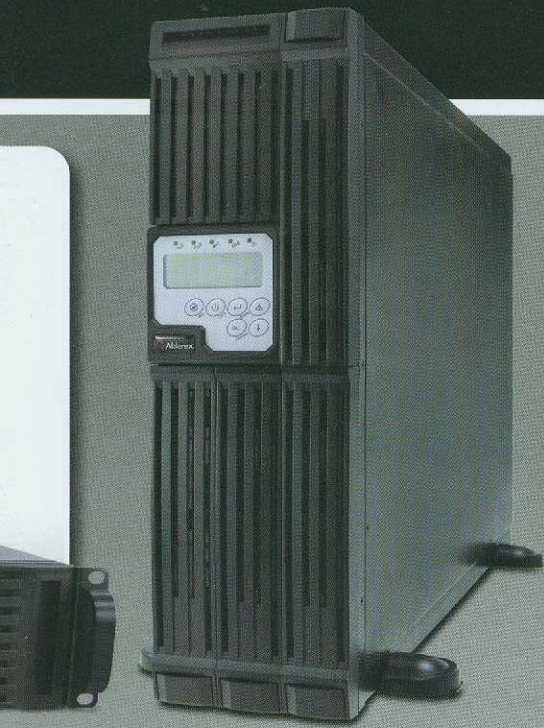

Full-time Digital Signal Processor Control

The Mars II Full Time DSP control system ensures a pure sinewave on the input and the output of the UPS. The DSP control also provides the user with simple access to the UPS systems' operational information via the front display panel.

True Double Conversion On-line Technology

The Mars II convertible UPS series completely regenerates utility power. It not only corrects and cleans the utility power, but the VFI (Voltage Frequency Independence) of the Mars II convertible series UPS complies with the international EN62040-3 standards.

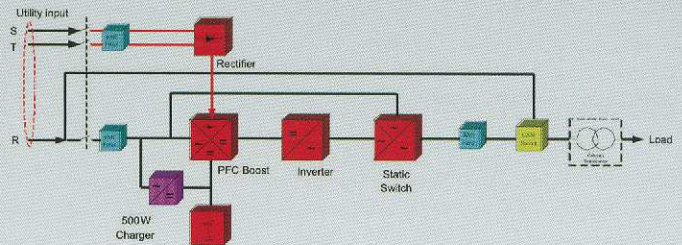
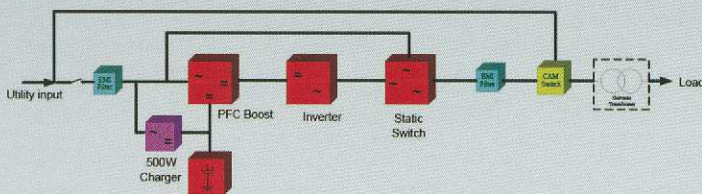

Dual Input Loops

The Mars II convertible series UPS provides single input connections as standard. Optional input terminal connections for the bypass and rectifier are available. A three-phase input and single phase output option is also available.

LCD/LED Mimic Panel

A precise LCD/LED display provides real time status and parameter readings. These include AC Input and Output Voltage, Frequency, Battery Voltage, Load Level, UPS temperature, etc. A full size, user-friendly microprocessor based LCD display, provides advanced monitoring functions and simple operation.

Energy-efficient UPS

The AC to AC efficiency of the Mars II convertible series UPS may be up to 90% at 25% load and higher with larger loadings in normal VFI operation. Using the ECO mode, an efficiency of up to 97% can be achieved.

Simple and Easy To Use

The LCD front panel provides direct access to the DSP controller. Changes to the UPS operational modes and parameters such as output voltage settings, fine adjustments for frequency, bypass voltage settings as well as alarms status may be easily performed.

Emergency Power Off

The Emergency Power Off enables users to remotely shutdown the UPS.



N+1 Parallel



Easy Communication



Hot Swappable



Power Share



Self-Diagnostics

Smart ECO Mode

Energy Saving using ECO mode.

Matching Battery Cabinet

Add matching battery cabinets and extend the back up time up to several hours.

Power Range and Runtime Scalability

The Mars II convertible series UPS provides an excellent return on your investment. The system is fully modular and allows you to increase the overall power output, battery runtime, and redundancy as your needs and requirements grow. The modular design eliminates any single point of failure.



Optional Galvanic Isolation Transformer Module

The Optional Galvanic Transformer Module provides isolation between the input and the output of the UPS and various secondary voltage 110/115/120/208/220/230/240Vac.

Model	Dimension (WxHxD, mm/inch)	Net Weight (kgs/lbs)		Application
		w/ MTBS**	w/o MTBS**	
MSII6000RT-GTM-WS*	440x88x660/17.3x3.5x26.0	42/92.5	41/90.3	For 4.5K/6K
MSII10000RT-GTM-WS*	440x132x660/17.3x5.2x29.0	49/108.0	48/105.8	For 8K/10K

* MSII6000RT-GTM-WOS/MSII10000RT-GTM-WOS are without MTBS.

** MTBS: Maintenance Bypass Switch

Parallel Distribution Boxes(Rack/Wall Mount Type)

Model	Description	Dimension (WxHxD, mm/inch)	Application
RacPDU-230	Max. 30A	326x88x100/12.8x3.5x4	Max. 1pce 4.5/6Kva
RacPDU-260	Max. 60A		Max. 2pcs 4.5/6Kva or 1pce 8K/10Kva
RacPDU-2120	Max. 120A	440x176x124/17.3x7.0x4.9	Max. 4pcs 4.5/6Kva or 2pcs 8K/10Kva
RackPDU-2200	Max. 200A		Max. 4pcs 8K/10Kva

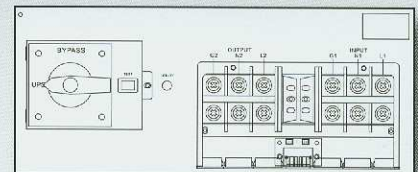

Advanced Battery Discharge Management

The Mars II convertible series UPS automatically manages the End-Discharge voltage of the internal batteries according to the load. The ABDM function prevents the deep discharge of the batteries during a power failure.

Hot Swappable Battery

The Mars II convertible series UPS allows users to easily replace the battery packs without interruption of the critical load.

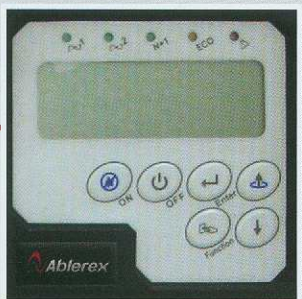
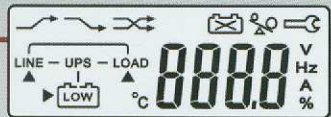

Silent Fan Control

The Mars II convertible series UPS employs variable-speed, forced air cooling fans. These fans will vary in speed according to the percentage of load. This variable-speed control ensures a low audible noise level making the Mars II convertible series UPS suitable for most environments including offices and hospitals.

Communication Capability

The Mars II convertible series UPS is shipped with monitoring and shutdown software. The software allows the control and graceful shutdown when Utility Power fails

- Remote testing of the major operating UPS functions.
- Communicate via SNMP/WEB card.
- Access UPS functions via the WEB.

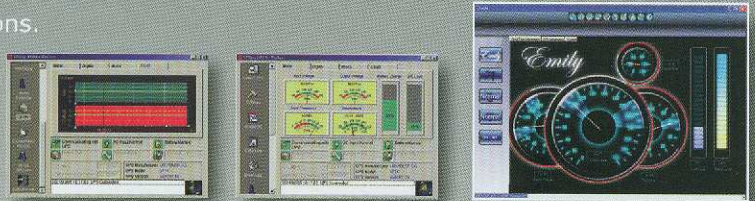

Optional External Battery Charger

With its isolation conversion technology plus precision control, the optional charger can be installed in Parallel operation up to 4 units. The specifications are as follows:

AC Input Range	100-280Vac, 45-65Hz
Maximum Power Output	1000W, continuously
Operation Mode	Constant Voltage with Current Limitation
Maximum Parallel Units	Up to 4 units
Protections	Over-temperature, Over-voltage, Against Output Short-Circuit & Isolated devices for Opposite Polarity Connection
Mounting	Mounted on the rear of the UPS or the wall
Dimension (WxHxD, mm/inch)	166x282x86 / 6.6x11.1x3.4
Net Weight (Kgs/lbs)	3.2 / 7.1



Variety of Customer Options Slots

The Mars II convertible series UPS also provides one or two additional Customer Options Communication slot(s) in addition to the standard RS232. An internal 2nd RS232, USB, RS485, Dry Contact, or WEB/SNMP card provides isolated contacts for industrial and remote alarm applications.

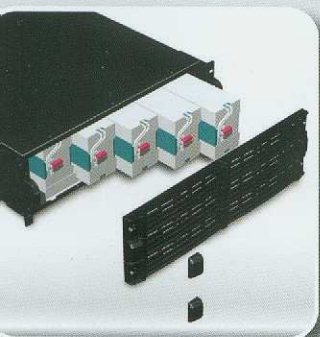

Super Compact Convertible Design

The Mars II convertible series UPS is small and compact. Install the UPS in a 19" rack and utilize the space efficiently.



Mars II Convertible Technical Specifications

Model	MSII4500RT	MSII6000RT	MSII6000C	MSII8000RT / 8000PRT	MSII10000RT / 10000PRT
INPUT					
Voltage Window	160 ~ 280Vac			160 ~ 280Vac (1Φ) / 277 ~ 485Vac (3Φ)*	
Frequency			45 ~ 65 Hz		
Phase / Wire	Single, Line + Neutral + Ground			Single, Line + Neutral + Ground (1Φ); Three, R, S, T + Neutral + Ground (3Φ)	
Power Factor	Up to 0.99 at 100% Linear Load				
Current THD (100% linear load)	<6% **				
OUTPUT					
Voltage Window	200 / 208 / 220 / 230 / 240Vac Selectable (208 / 120Vac optional)				
Voltage Adjustment	Nominal +1%, +2%, +3%, -1%, -2% or -3%				
Voltage Regulation	±2%				
Capacity	4500VA / 3150W	6000VA / 4200W		8000VA / 5600W	10000VA / 7000W
Rated Power Factor	0.7 Lagging				
Wave Form	Sine Wave, THD < 3% (no load to full load)				
Frequency Stability	±0.2% (Free Running)				
Frequency Regulation	±1Hz ; ±3Hz				
Transfer Time	0ms				
Crest Factor	3:1				
Efficiency (AC to AC, Normal)	Up to 90%				
Efficiency (AC to AC, ECO)	Up to 95%				
Autonomy	≧ 12 min	≧ 8 min	≧ 3 min		≧ 5 min
DC Start	Yes				
BATTERY					
Type	Sealed Lead Acid Maintenance Free				
Capacity	12V / 7AH		12V / 5AH	12V / 7AH	12V / 9AH
Quantity	20pcs				
Voltage	240Vdc				
Recharge Time	4 hours to 90%			5 hours to 90%	
DISPLAY					
Status on LED + LCD	Line Mode, Backup Mode, ECO Mode, Bypass Supply, Battery Low, Battery Bad/Disconnect, Overload, Transferring with interruption & UPS Fault.				
Readings on LCD	Input Voltage, Input Frequency, Output Voltage, Output Frequency, Load Percentage, Battery Voltage & Inner Temperature.				
Self-Diagnostics	Upon Power-on, Front Panel Setting & Software Control, 24-hour routine checking				
ALARMS					
Audible and Visual	Line Failure, Battery Low, Transfer to Bypass, System Fault Conditions				
PROTECTION					
Overload (w/simulated thermal tripping I-T Curve)	Inverter Supply: 105%~150% for 160 seconds ~ 2 cycles before switching bypass. Bypass Supply: 105%~200% for 500 seconds ~8 cycles before stopping supply load.				
Short Circuit	Switch off Immediately				
Overheat	AC Mode: Switch to Bypass Backup Mode: Switch off the UPS				
Battery Low	Alarm and Switch Off				
Noise Suppression	Complies with EN62040-2				
Spike Suppression	Complies with EN61000-4-5				
Heat Dissipation (At Full Linear Load)***	Without Isolated Transformer Module	< 450W			10K: <600W 10KP: <550W
	With Isolated Transformer Module	< 615W			10K: <1100W 10KP: <1050W
Leakage Current	< 3mA at Full Load				
PHYSICAL					
Dimensions WxHxD (mm / inch)	440x88x680 / 17.3x3.5x26.8		440x176x680 / 17.3x7.0x26.8	440x132x680 / 17.3x5.2x26.8	
Input/Output Connection	Hardwire				
External Battery Connection	Plug-in & Play				
Net Weight (kgs / lbs)	24.0 / 52.9		52.0 / 114.6	1Φ: 26.0/57.3; 3Φ: 28.0/61.7	

Model	MSII4500RT	MSII6000RT	MSII6000C	MSII8000RT / 8000PRT	MSII10000RT / 10000PRT
ENVIRONMENT					
Operating Temperature	0 to 40°C / 32 to 104°F				
Temperature Warning	The battery design life is based on a temperature of 25°C/ 77°F, Ambient temperature above this range will affect battery life				
Altitude	0-2000M/6600ft up to 40°C/104°F, 3000M/9900ft up to 35°C/95°F				
Humidity	90% RH Maximum, Non-Condensing				
Noise	<50dB (at 1 Meter/3.3ft)				
COMPUTER INTERFACE					
Interface Type	Standard RS232 Interface				
Communication Slots	2 nd RS232, USB, RS485, Relay Contact, SNMP/WEB Card, etc.				
SAFETY CONFORMANCE					
Quality Assurance	ISO9001 Certified				
Safety Standard	EN62040-1-1, UL1778				
EMC Standard	EN62040-2, EN61000-3-2, EN61000-3-3, FCC Class A				
Marks	CE, cUL, UL				

BATTERY BANK					
Model	Battery Type	Maximum Quantity	Without Batteries kgs / lbs	With Batteries kgs / lbs	Dimension(WxHxD) mm/inch
BBC20J0007	7 AH	20pcs	18 / 39.7	68.0 / 149.8	440x132x680 / 17.3x5.2x26.8
BBC20N0009	9 AH				

- * (160-176Vac for 1-phase input model or 277-305Vac for 3-phase input model at <75% load)
- ** 3-phase input model <30%
- *** reference data

Specifications are subject to change without prior notice.

